

MANUAL DE MONTAGEM

## QUEBRA-CABEÇA 3D CASINHA TURMA DA MÔNICA



**XALINGO S/A INDÚSTRIA E COMÉRCIO**

BR 471, km147 - SANTA CRUZ DO SUL- RS - BRASIL - CEP 96835-642

CNPJ 95.425.534/0001-76.

SAC: (51) 3719 - 9800 - sac@xalingo.com.br

<https://pt-br.facebook.com/xalingo> - [www.xalingo.com.br](http://www.xalingo.com.br)

GUARDAR PARA EVENTUAIS CONSULTAS / GUARDAR PARA EVENTUALES CONSULTAS / KEEP THIS FOR FURTHER CONSULTATIONS.

Ref.: 1044.3

+ 3 ANOS



Para iniciar a montagem da sua casinha separe as peças conforme indicado:

01 - Encaixe a parede lateral na peça traseira da casinha.

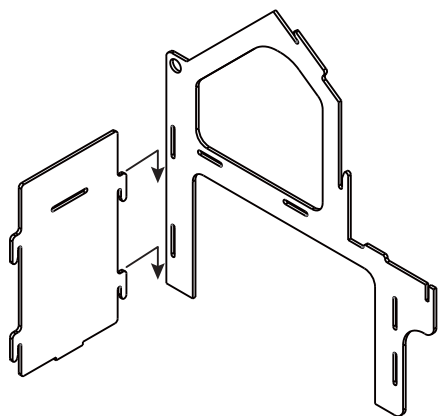

02 - Encaixe peça frontal na parte lateral da casinha.

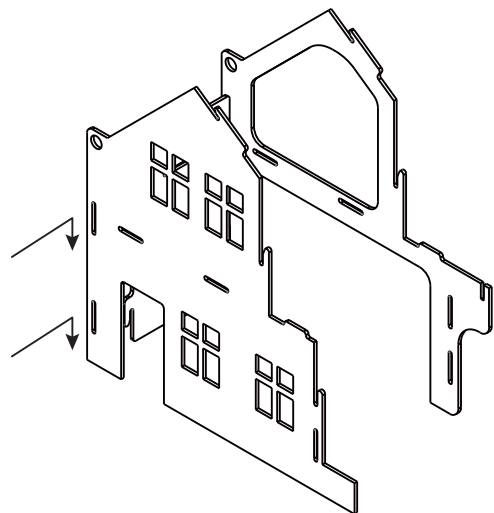

12 - Banco

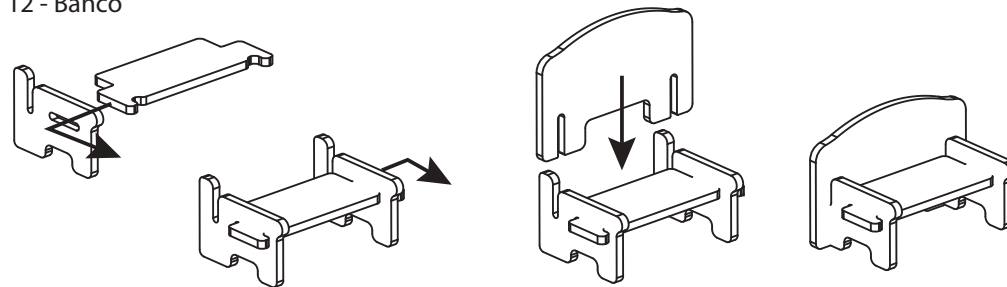

13 - Cama

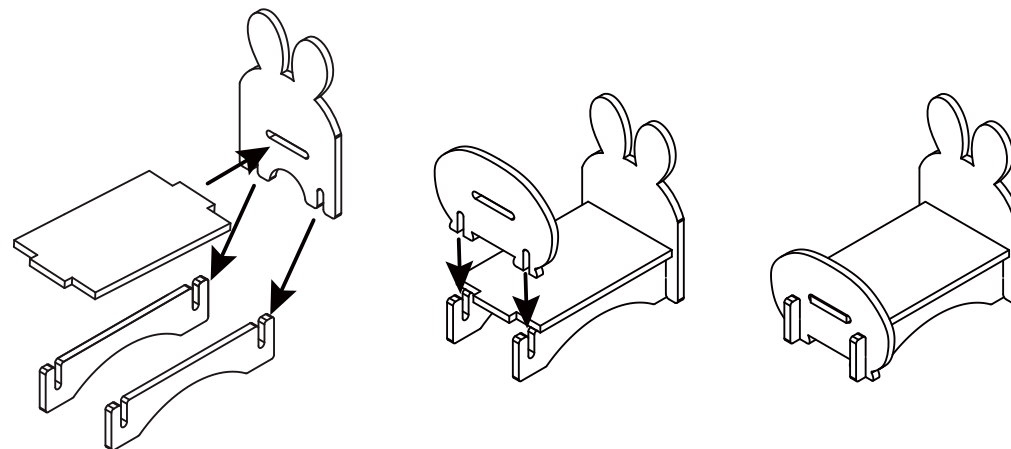

14 - Encaixe os personagens no pedestal.

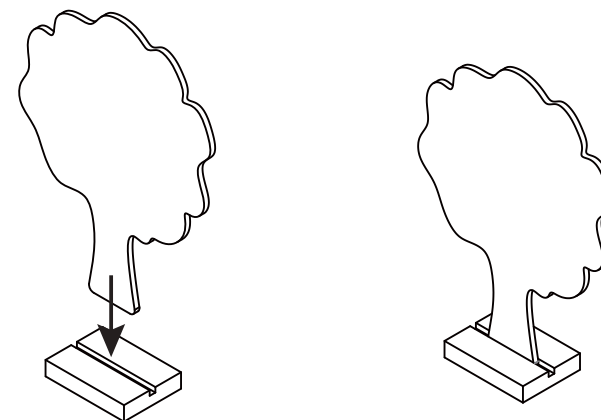

05 - Encaixe o arco da sala fixando-o nos buracos do piso e a estrutura da escada nos ganchos laterais.

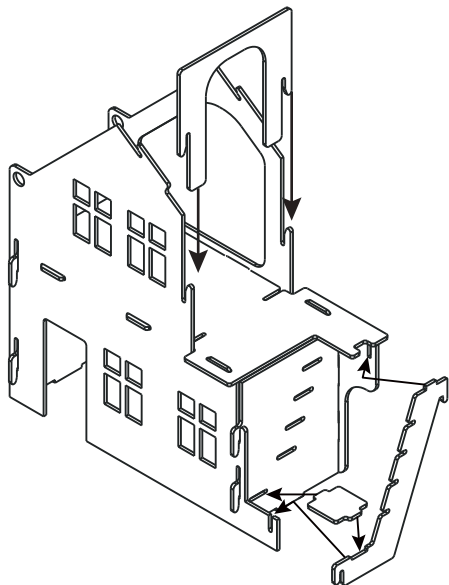

06 - Encaixe o telhado no gancho superior.

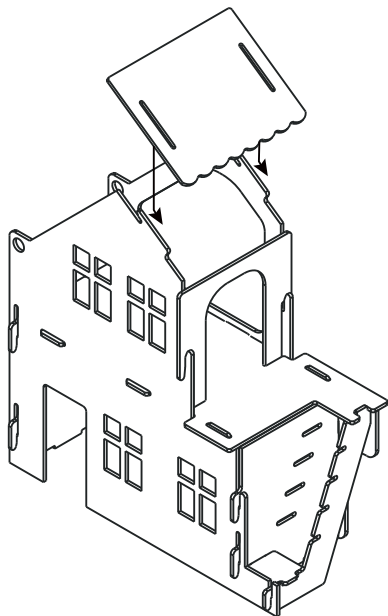

07 - Encaixe a parte movel do telhado nos furos da estrutura.

Para facilitar, encaixe uma aba de cada vez no sentido diagonal.

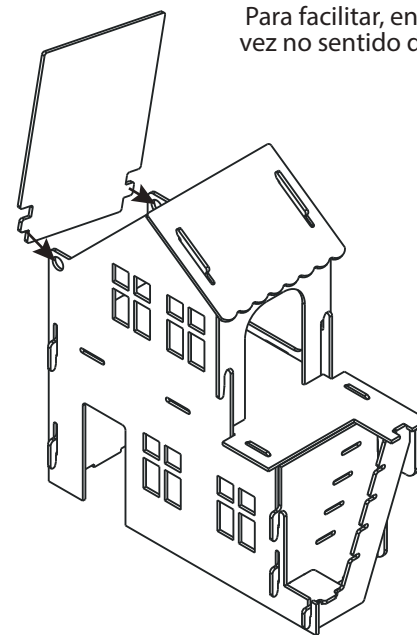

08 - Encaixe os degraus na lateral da casinha e na estrutura.



09 - Encaixe a casinha na base.

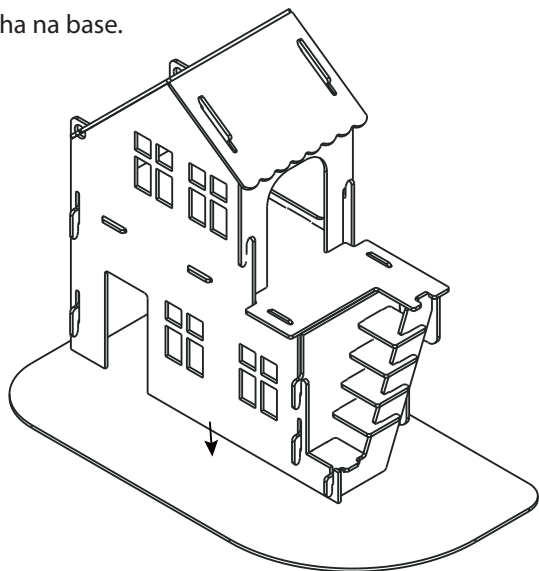

Montagem dos móveis:

10 - Fogão

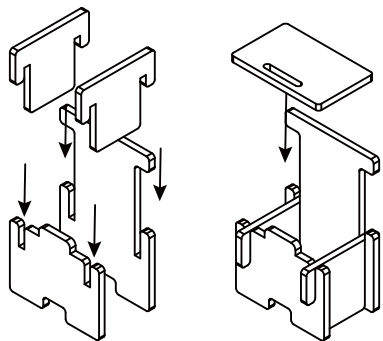

11 - Abajur

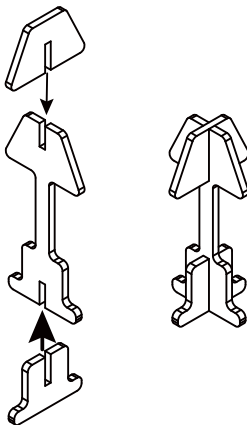

12 - Cadeira

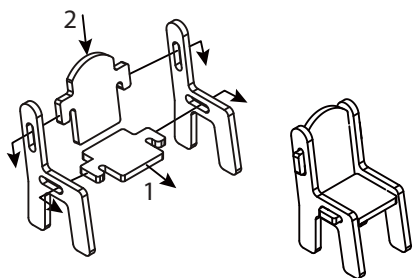

13 - Mesa

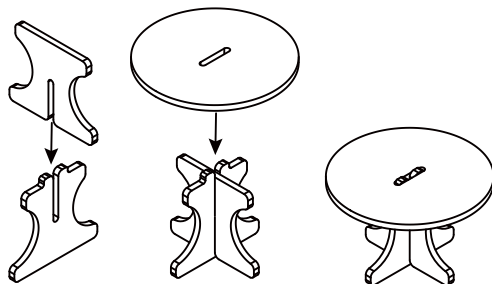

03 - Encaixe a lateral com suportes da escada.

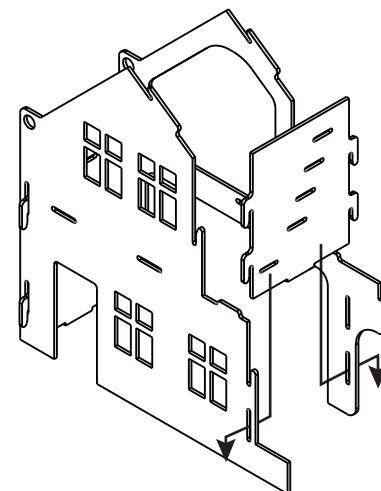

04 - Encaixe o piso na estrutura previamente montada.

