

# MANUAL DE MONTAGEM CIDADE HOT WHEELS



**XALINGO S/A INDÚSTRIA E COMÉRCIO**  
BR 471 - km147 - SANTA CRUZ DO SUL - RS - BRASIL CEP 96835-642  
FONE / FAX: (51) 3719 - 9800 / 3719 - 1009 CNPJ 95.425.534/0001-76  
SERVIÇO DE INFORMAÇÃO AO CONSUMIDOR - FALE CONOSCO:  
www.xalingo.com.br - e-mail: vendas@xalingo.com.br  
GUARDAR PARA EVENTUAIS CONSULTAS.  
GUARDAR PARA EVENTUALES CONSULTAS.  
KEEP THIS FOR FURTHER CONSULTATIONS.

Ref.: 2257.6

+ 3 ANOS



Pronto para um novo desafio Hot Wheels? Vamos montar uma cidade super radical para brincar com seus carrinhos.

Esse produto é composto pelas seguintes partes, 5 chapas com as peças de cenário e um tabuleiro de papel.

Destaque e já agrupe as peças pelas letras nos desenhos, assim você terá as peças avulsas para montagem. Com os grupos de peças da mesma estrutura você pode iniciar a montagem. Vamos começar!

PRÉDIO (A) - POSTO - 9 pçs

01

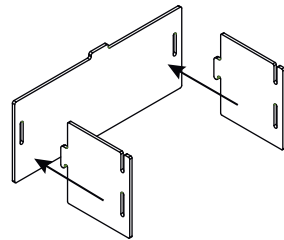
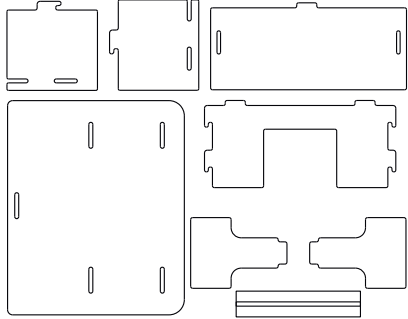

02

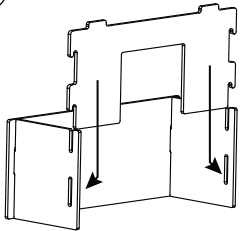

03

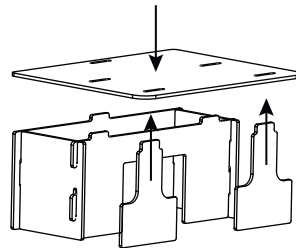

04

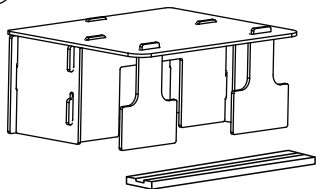

05

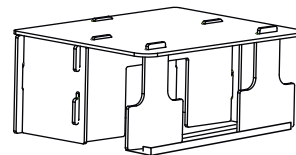

Atenção: Observe a posição dos encaixes para facilitar a montagem. As artes devem ficar sempre para o lado externo da montagem.

Lembre-se: Você pode brincar montando e desmontando os prédios, ou utilizar cola para ter o cenário permanente.

03

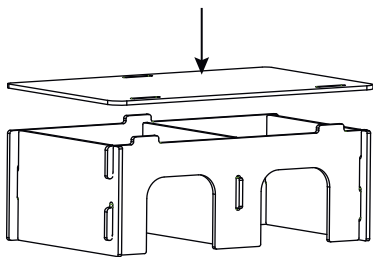

04

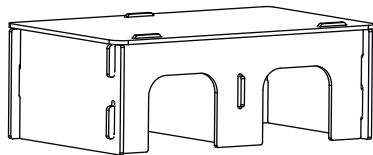

PRÉDIO (D) - OFICINA - 5 pçs

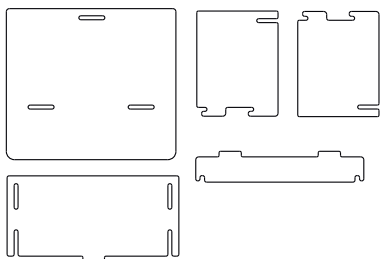

02

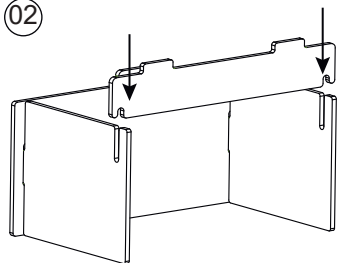

01

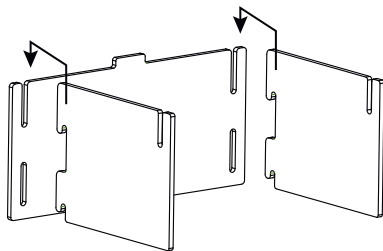

03

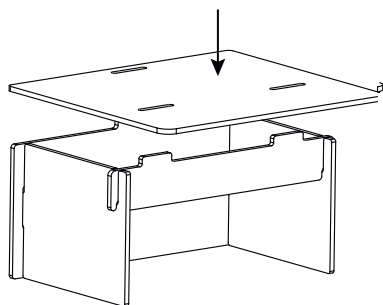

04

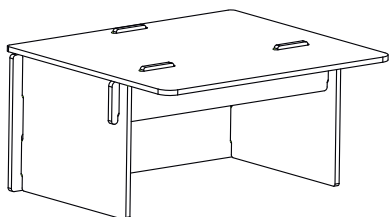

03

PRÉDIO (E) - ESTACIONAMENTO - 12 pçs

01

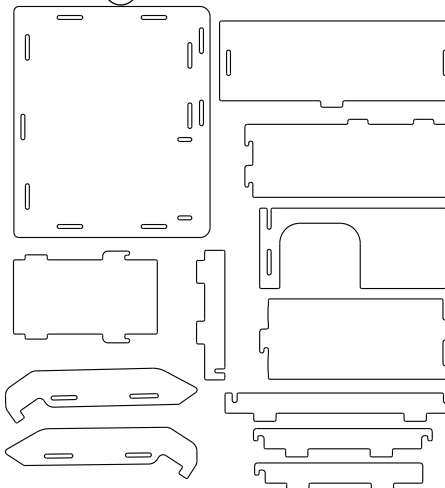

02

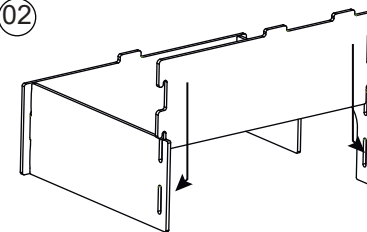

03

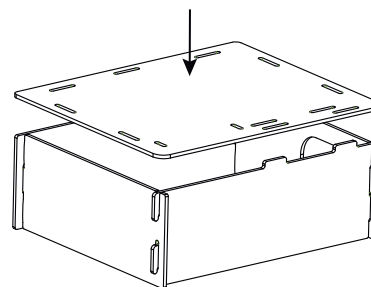

04

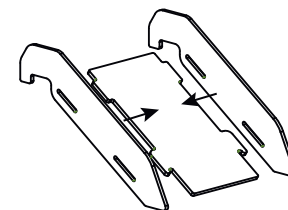

05

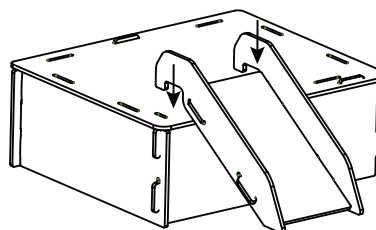

06

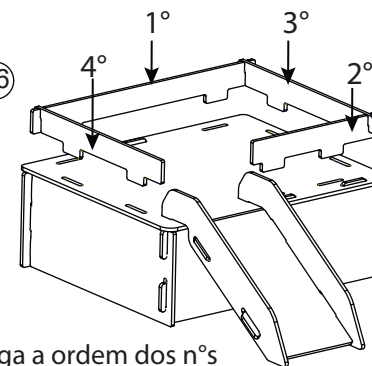

07

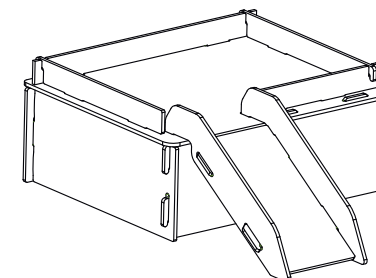

Siga a ordem dos n°s para obter o encaixe ideal.

04

SEMÁFOROS (F) e (G) - 6 pçs

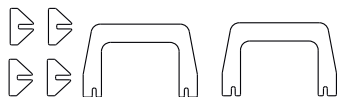

01

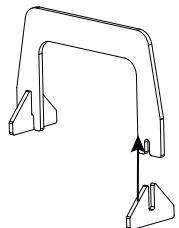

02

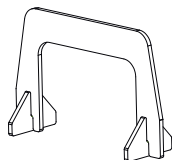

VIADUTO (H) - 7 pçs

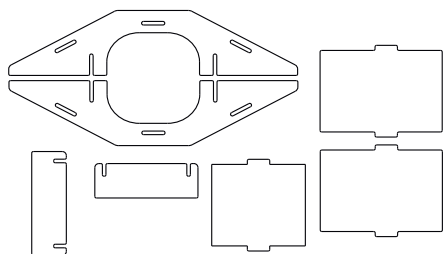

02

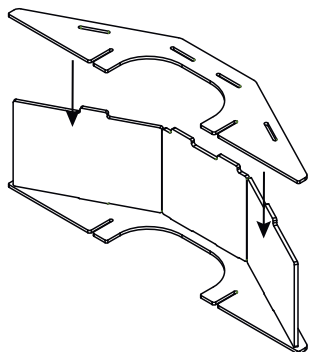

01

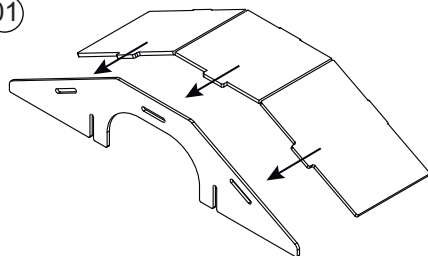

Para o próximo passo, apoie a peça para facilitar o manuseio.

03

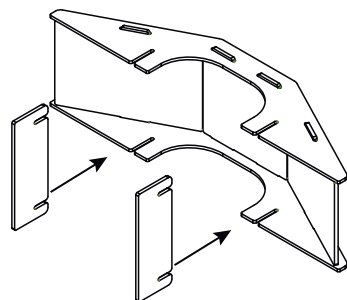

Após o encaixe retorne a posição vertical.

04

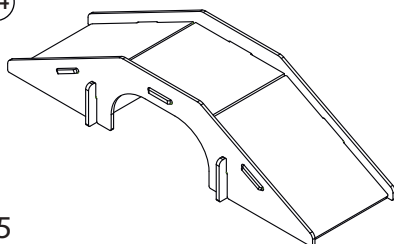

Posicione os prédios sobre o tabuleiro e pronto! A diversão está prestes a começar.

05

PRÉDIO (B) - LAVA RÁPIDO - 5 pçs 01

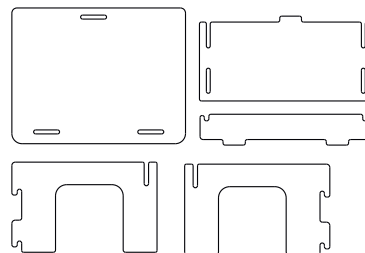

02

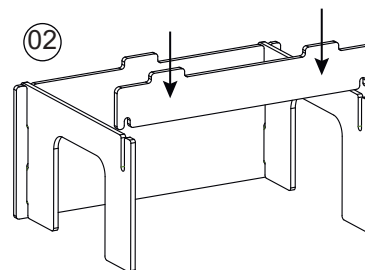

03

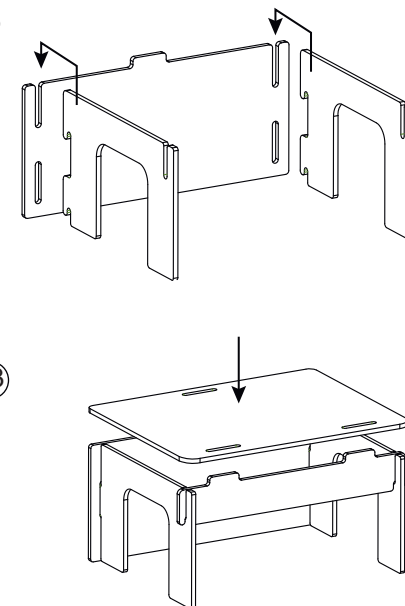

04

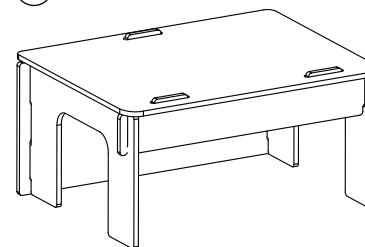

PRÉDIO (C) - POLÍCIA / BOMBEIRO - 6 pçs

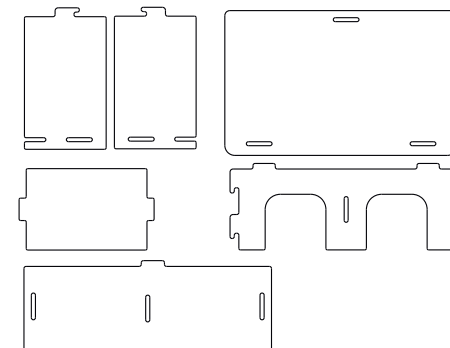

01

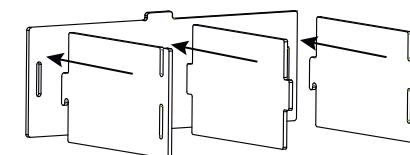

02

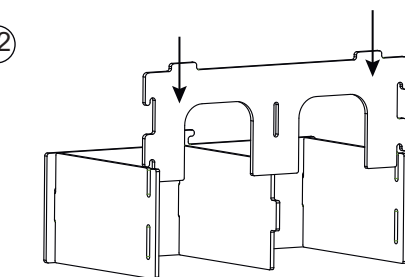

02