

MANUAL DE MONTAGEM

CASINHA DE MADEIRA LITTLE HOUSE VERÃO



XALINGO S/A INDÚSTRIA E COMÉRCIO
BR 471 - km147 - SANTA CRUZ DO SUL - RS - BRASIL CEP 96835-642
FONE / FAX: (51) 3719 - 9800 / 3719 - 1009 CNPJ 95.425.534/0001-76
SERVIÇO DE INFORMAÇÃO AO CONSUMIDOR - FALE CONOSCO:
www.xalingo.com.br - e-mail: vendas@xalingo.com.br
GUARDAR PARA EVENTUAIS CONSULTAS.
GUARDAR PARA EVENTUALES CONSULTAS.
KEEP THIS FOR FURTHER CONSULTATIONS.

Ref.: 5033.2

+ 3 ANOS



Hora de montar a sua casinha, preste atenção nas peças e encaixes, para facilitar separe as peças indicadas antes de começar a montar as etapas.

Modo de brincar:

Você pode brincar montando e desmontando a casinha, ou utilizar cola para ter a casa permanente.

Passo 01 - use as seguintes peças:

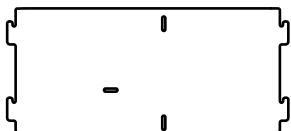
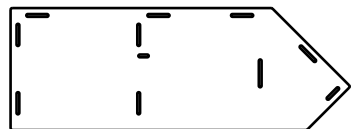

①

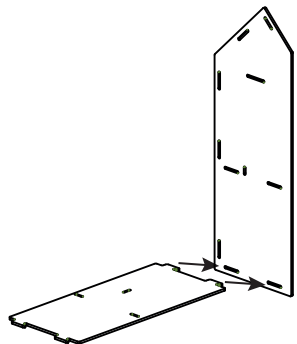

②

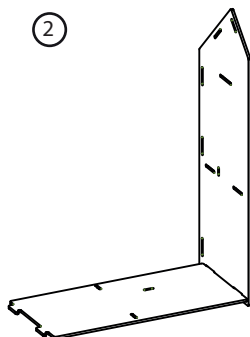

Passo 02 - use as seguintes peças:

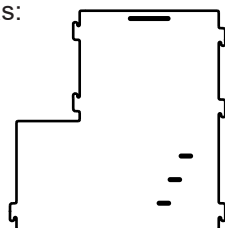
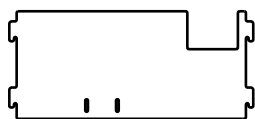

③

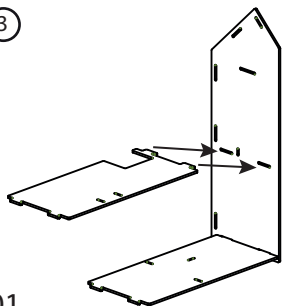

④

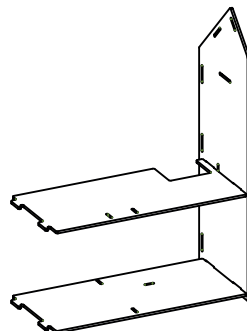

ÁRVORES

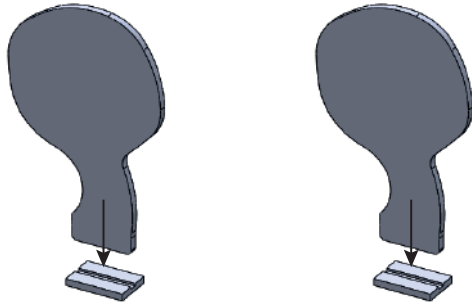
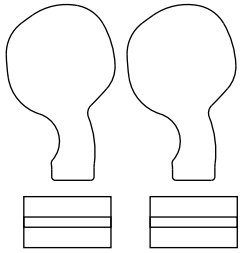

MENINA

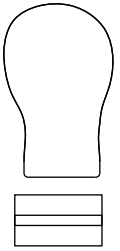

Posicione os móveis dentro da casinha e divirta-se brincando com os personagens!



09

5

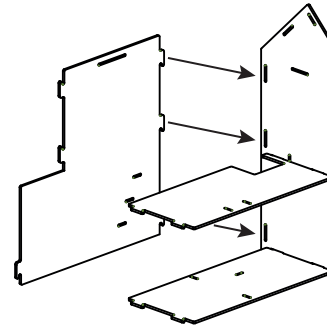

6

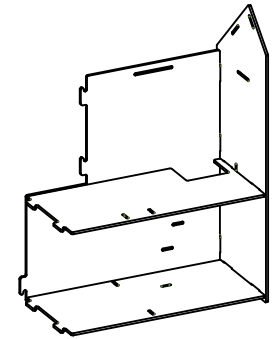

Passo 03 - use as seguintes peças:

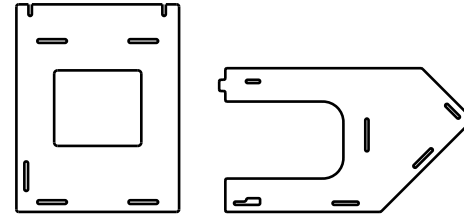

7

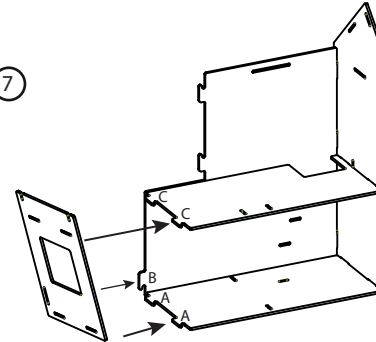

8

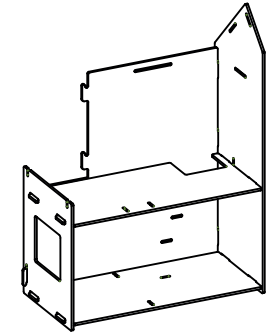

Para facilitar essa etapa, com a peça lateral levemente inclinada encaixe primeiro a parte inferior (A), deslocando-a para frente. Depois encaixe do fundo (B) e por último os encaixes do piso superior (C).
ATENÇÃO: Cuidado para não deixar a peça B sobreposta a A.

9

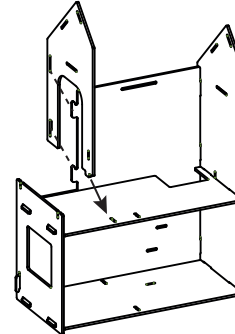

10

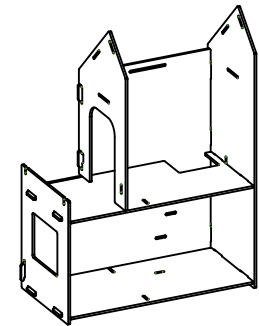

02

Passo 04 - use as seguintes peças:

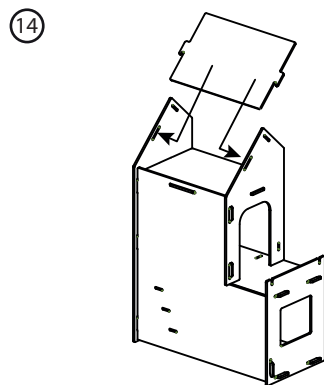
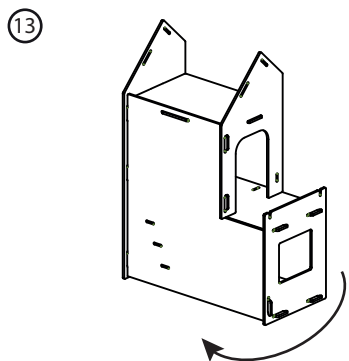
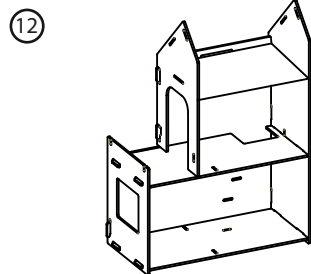
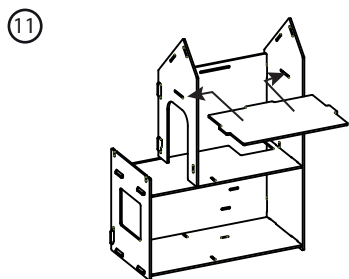
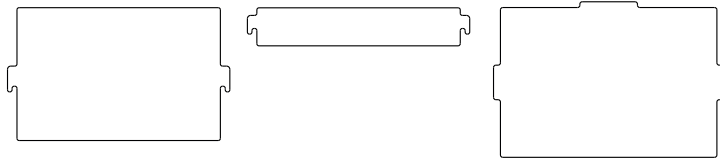

Vire a casinha para facilitar a visualização do encaixe.

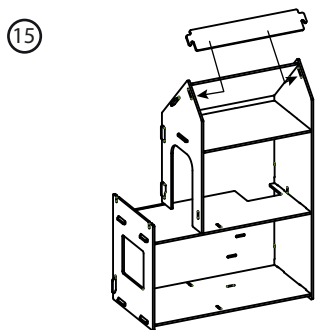

Retorne a posição frontal para continuar.

03

03

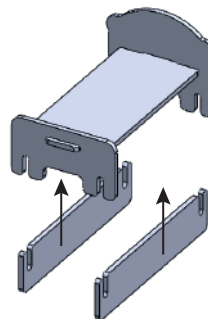

04

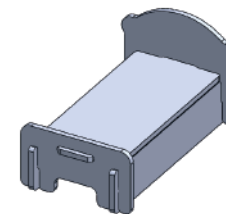

MESINHA

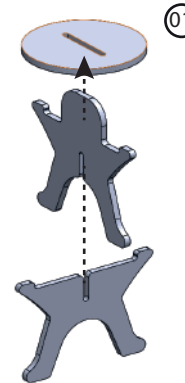
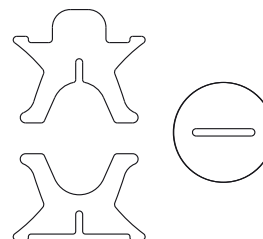

02



ANIMAIS



01

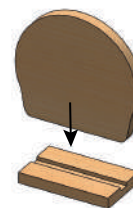

02

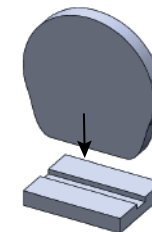

08

PENTEADEIRA

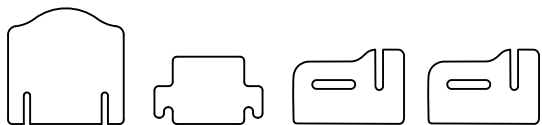

01

02

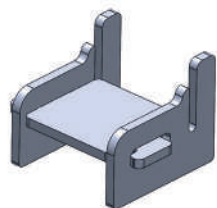
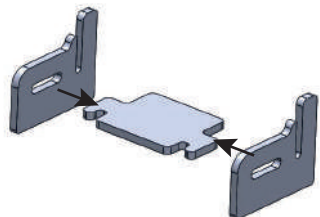

03

04

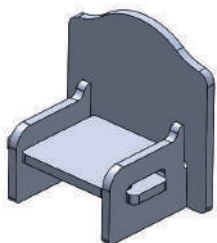
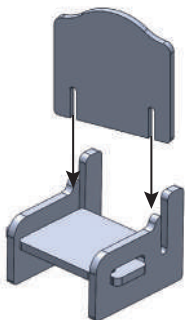

CAMA



01

02

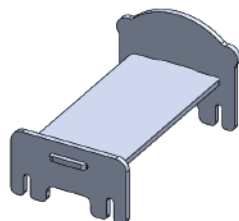
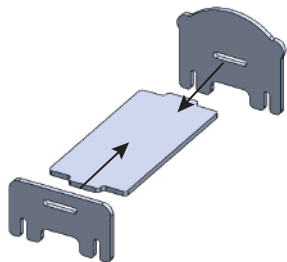

07

Passo 04 - use as seguintes peças:

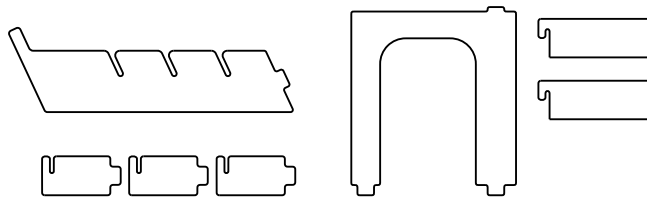

17

18

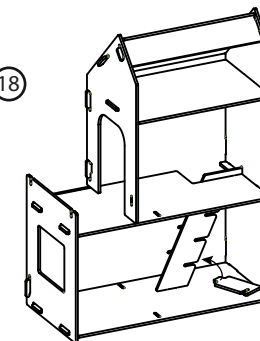
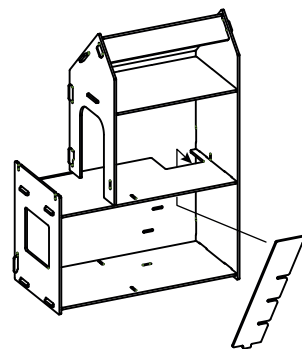

Encaixe todos os degraus na lateral da escada, fixando na parede do fundo, como no exemplo acima.

19

20

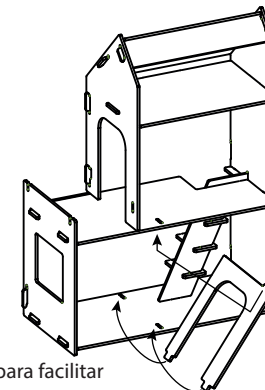
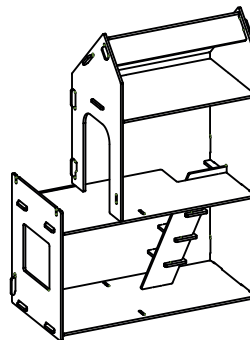

Incline a peça para facilitar o encaixe.

21

22

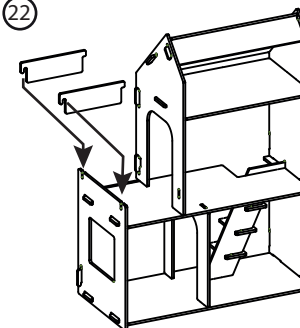
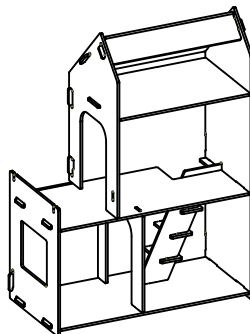

04

Passo 05 - use as seguintes peças:

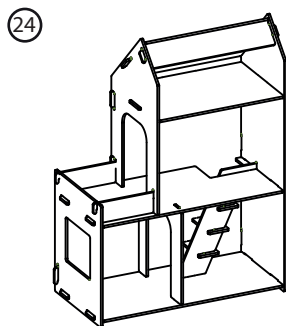
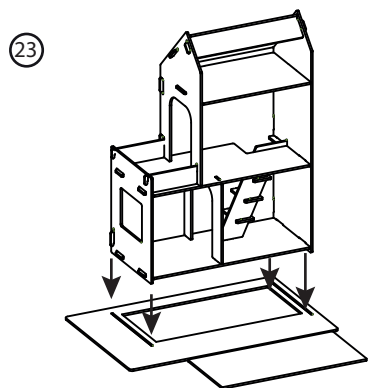
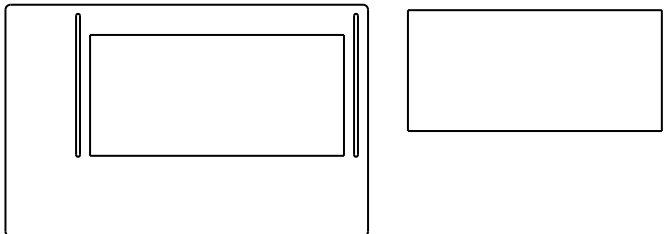

Agora a casinha está pronta! Vamos montar os móveis. Separe as partes de cada peça e siga as setas para obter os movimentos de encaixe.

POLTRONA:

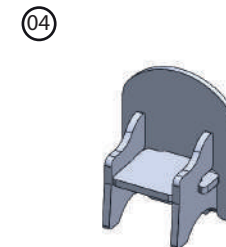
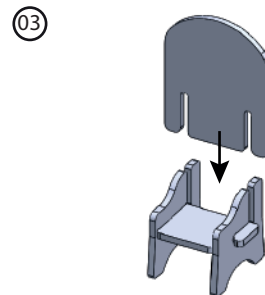
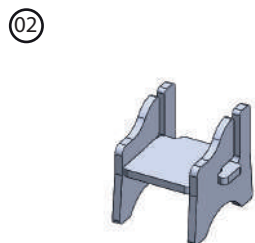
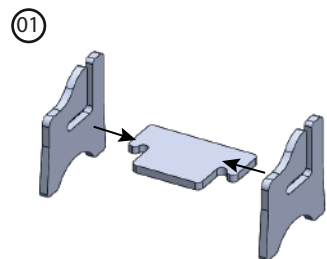
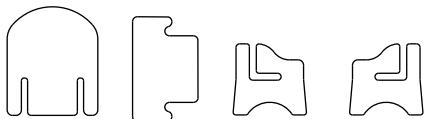

SOFÁ | BANCO EXTERNO

